

GAMA

by
bürotime

technical document



GAMA



“Pedagogical approaches that change along with technology accelerates the alteration towards student-oriented, active learning environments while creating opportunities for new learning methods. As Burotime, inspired by active learning approaches that do not limit education to defined spaces, we offer effective solutions that will convert every corner of the educational institution into a learning space.”



Combining durability and comfort, Gama offers ergonomic solutions for learning spaces with single and double seating options that allow different space designs and height alternatives suitable for different age groups.





The bookshelf placed under the table top, the bag hanger mounted on the table legs, pen and tablet holder on the table top provide an organized working environment reinforces the sense of belonging and active participation to the learning space.

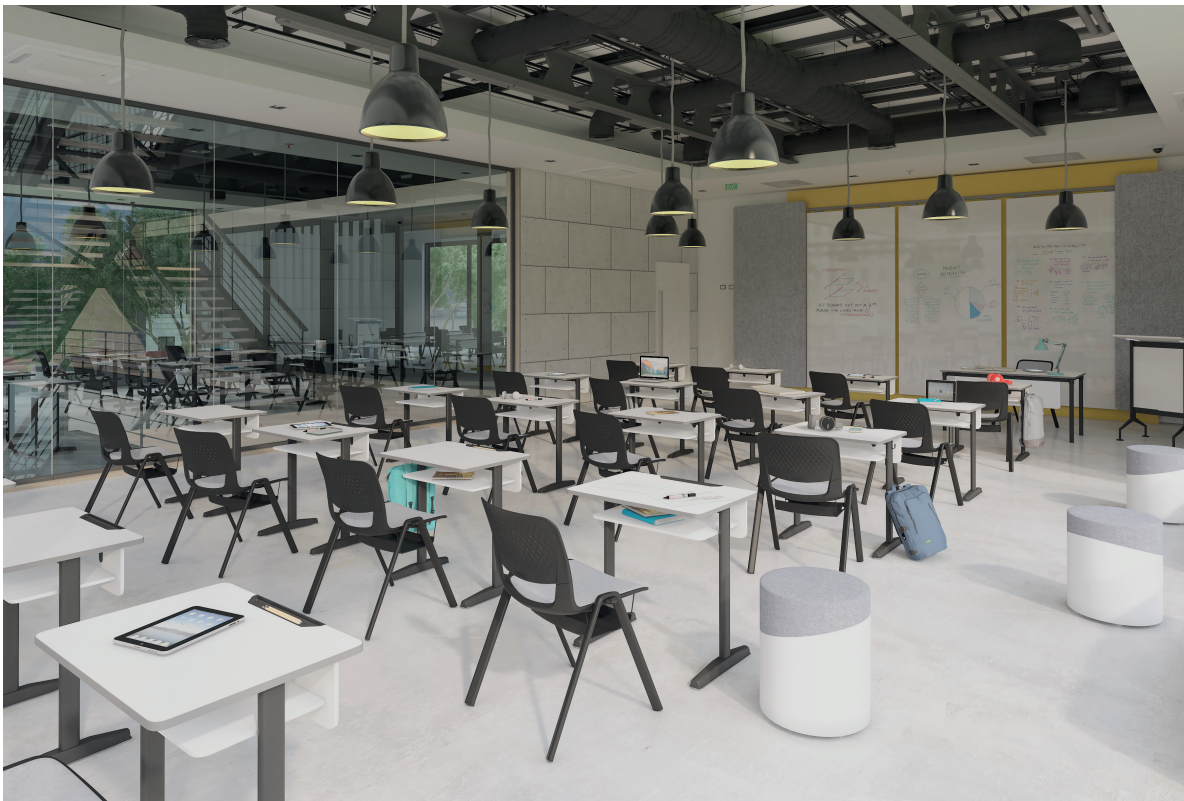

product family _____



single desk



double desk

table sizes _____

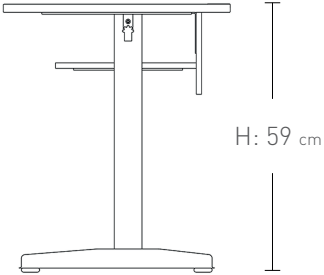
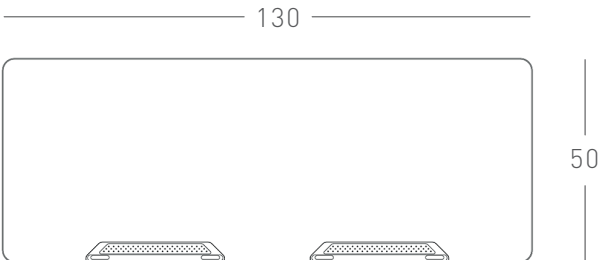
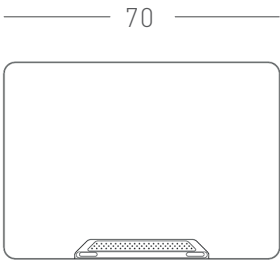

small
6-8 years

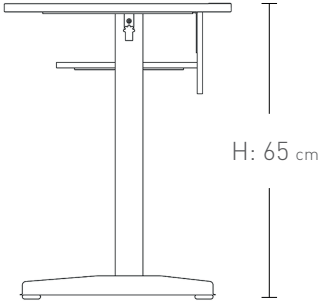

medium
8-11 years

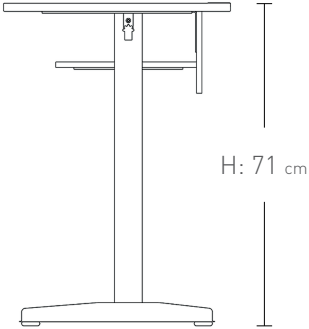

large
11-14 years



color options

melamine

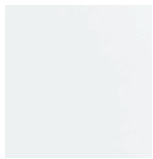

white

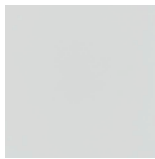

grey

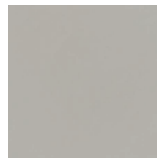

sand

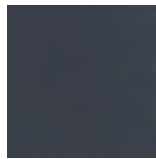

antrachite



samba walnut



oleaster



ash oak



hazelnut

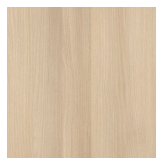

acacia

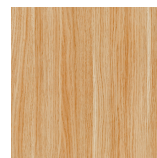

natural oak



african oak

metal

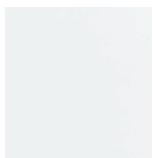

white

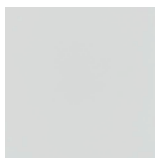

grey

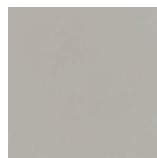

sand

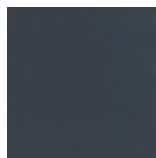

antrachite



black